

PORTABLE BENCH for CHASSIS

model: BCT-18P

Easy to install, very easy to move

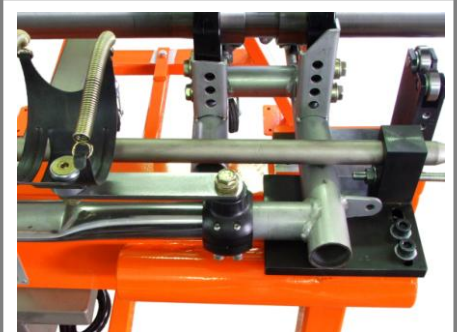
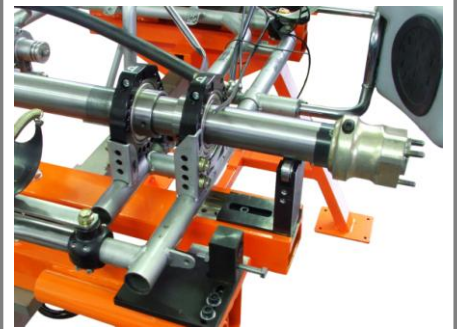

The **1st** Professional Portable Bench for Kart Chassis

Available with some items to verify, to control and to restore the Kart Chassis of all brands.

Photo Gallery:



EFFECIEMME s.n.c. di Cereda M. & C. Via Dell'Artigianato 22 - 20881 BERNAREGGIO (MB) ITALIA
 tel.: +39 039 6902705 - fax: +39 039 6902932 - e-mail: effeciemme@effeciemme.com - sito web: www.effeciemme.com



FEATURES AND DIMENSIONS

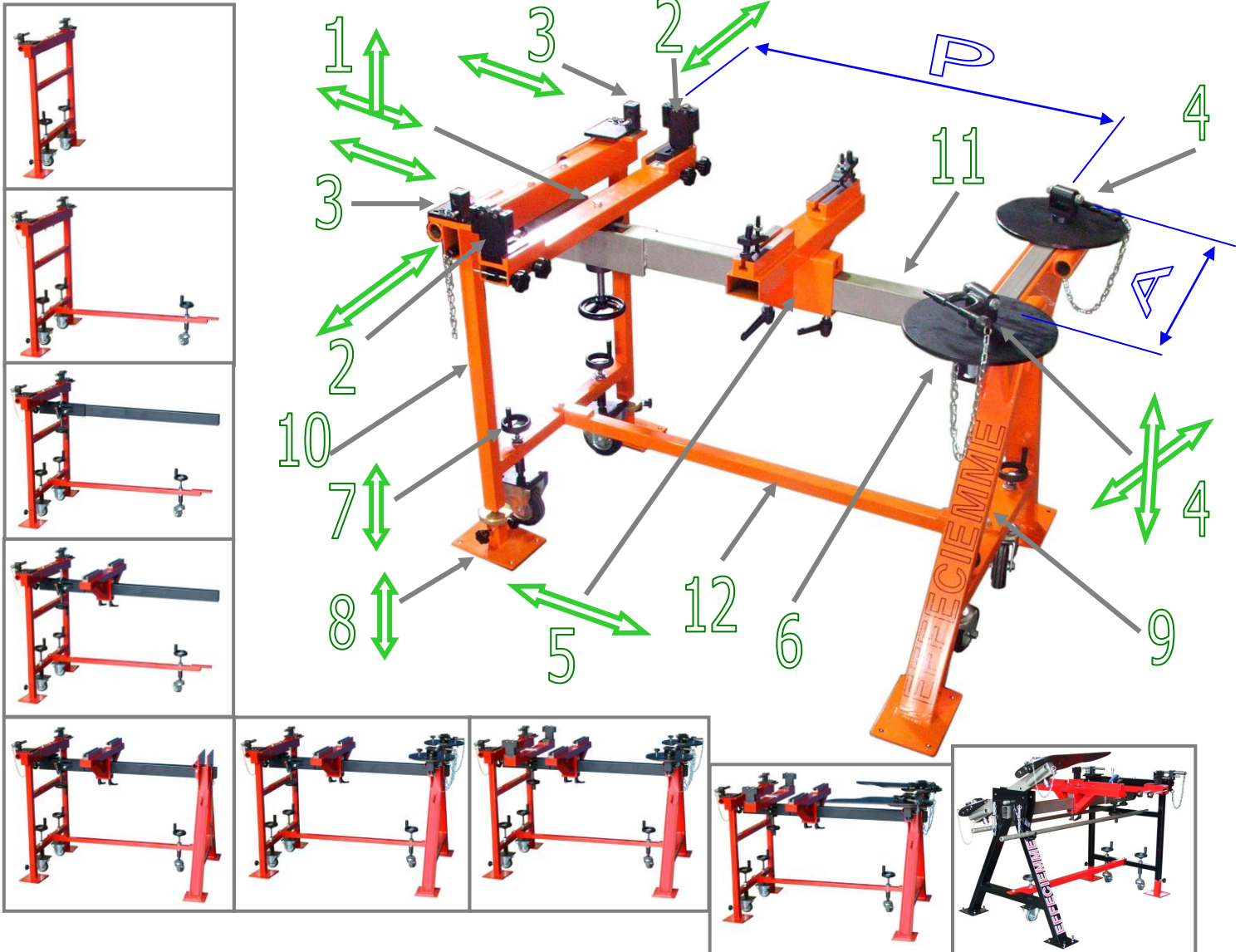

All rights reserved. Design and specification are subject to change without notice

REF.	DESCRIPTION	DISPLACEMENT (mm) - NOTES	DIMENSIONS-WEIGHT
P	AXLE BASE	Longitudinal: $-30 \leftarrow 0 \rightarrow +60$	min. 1025 - max 1065
A	WIDTH	Transversal: $-90 \leftarrow 0 \rightarrow +90$	min. 580 - max 760
1	AXLE CROSSBAR	Longitudinal: $-30 \leftarrow 0 \rightarrow +60$ Vertical: $0 \rightarrow +60$ mm	
2	AXLE HOLDERS WITH BEARINGS	Transversal: each $-20 \leftarrow 0 \rightarrow +50$ mm	
3	BACK BLOCK (*)	Longitudinal: each $-20 \leftarrow 0 \rightarrow +70$ mm	
4	FRONT BLOCK (*)	Transverse: each ± 90 mm Vertical: $-15 \leftarrow 0 \rightarrow +15$ mm	
5	CENTRAL CROSS HOLDER (*)	Along all central bar	
6	MOBILE HOLDER (*)	INSTRUMENT HOLDER SURFACE	Dia. 300 x 10 mm
7	BACK and FRONT WHEELS	Vertical: ± 30 mm	
8	BACK FEET (*)	HEIGHT ADJUSTABLE FOR LEVELLING	
9+10	FORWARD STAND + REAR STAND (*)		KG 34 + KG 22
11+12	UPPER CROSSBAR + LOWER CROSSBAR (*)		KG 15 + KG 5
1+5	AXLE CROSSBAR + CENTRAL CROSS HOLDER		KG 10 + KG 15
	1x POWER LEVER	CHASSIS RESTORE	(*) STANDARD EQUIPM.
	1x CONTRAST LEVER	TO KEEP BALANCE	(*) STANDARD EQUIPM.
	1x COMPLETED POWER LEVER	SUPPORTS ANGLE "C" RESTORE	ON REQUEST
	TOTAL WEIGHT (LEVERS AND OTHER ITEMS INCLUDING)		KG 158 - 160



EFFECIEMME s.n.c. di Cereda M. & C. Via Dell'Artigianato 22 - 20881 BERNAREGGIO (MB) ITALIA
tel.: +39 039 6902705 - fax: +39 039 6902932 - e-mail: effeciemme@effeciemme.com - sito web: www.effeciemme.com



ADVISE ITEMS

(can be bought separately)

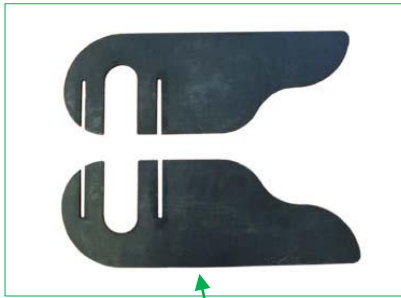

BCT-PR 2x Front Planes Reflected



BCT-LS 1x Leverage Holder for Law Enforcement

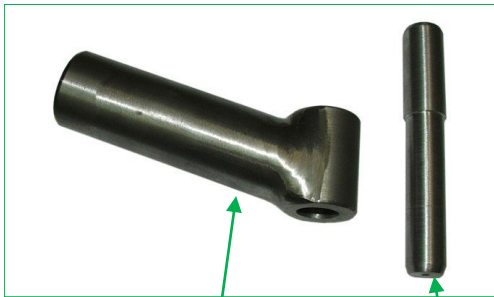

TRT2.4MS 1x Hab + 1x Pin for «C» Frame (*)

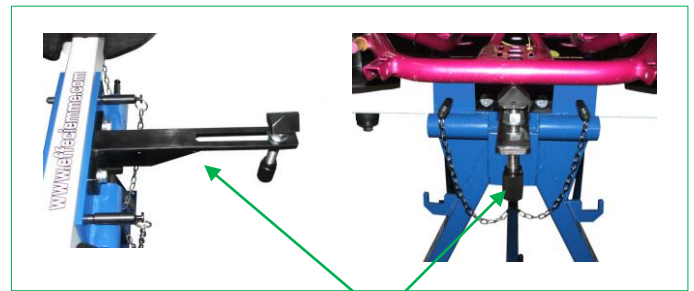

BCT18-PUN 1x Adjustable Central Tip

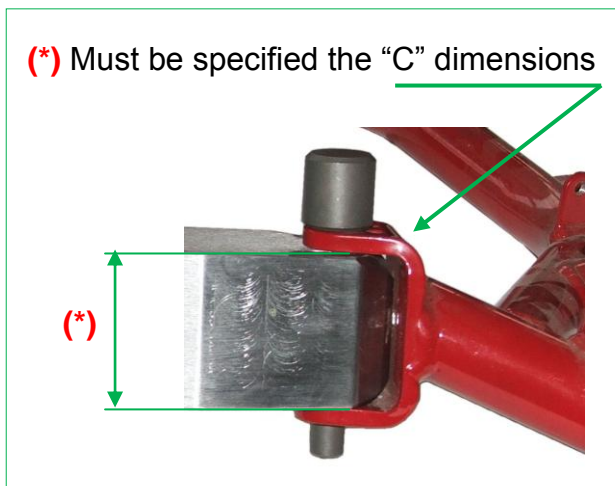

AVAILABLE ON REQUEST



LKC-125 Laser Kit Convergence

All rights reserved. Design and specification are subject to change without notice

